

HPCIE-Q470

Half-size PICMG 1.3 CPU Card supports LGA1200 Intel® 10th/11th Gen. Core™ i9/i7/i5/i3, Pentium®, Celeron® CPU with Q470/Q470E, DDR4 SO-DIMM, HDMI™, Dual Intel® 2.5GbE, USB 3.2 Gen2, SATA 6Gb/s, M.2, IAUDIO, and RoHs

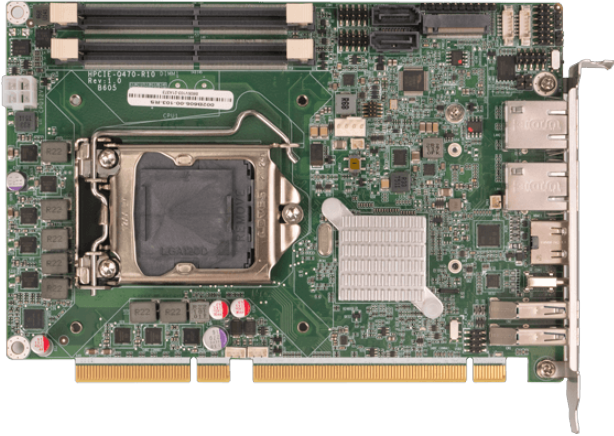

Features

1. LGA1200 Intel® 10th/11th Generation Core™ i9/i7/i5/i3, Celeron® and Pentium® processor
2. Dual-channel DDR4 2933MHz
3. Support Dual Intel® 2.5GbE
4. Support M.2 A key for WLAN expansion, M key for PCIe NVMe storage

Specifications

Form Factor	
Form Factor	Half Size Single Board Computer
System	
CPU	LGA1200 Intel® 10th/11th Gen. Core™ i9/i7/i5/i3, Pentium® and Celeron® processor (Support up to 65w)
Chipset	Intel® Q470/Q470E
Memory	2 x 260-pin 2933 MHz Dual-channel DDR4 SO-DIMM, support up to 64G
Memory Max.	up to 64GB
Cooling method / System Fan	1 x CPU fan connector (1x4 pin)
Physical Characteristics	
Dimensions (LxWxH) (mm)	185 mm x 126 mm
Net Weight	420g
Storage	
Storage	2 x SATA : 6Gb/s (support RAID 0/1)
	1 x M.2 (NGFF) : M Key (2242/2280) with PCIe Gen3 x4, support NVME storage
I/O Interface	
Display Output	1 x HDMI™ : up to 4096 x 2160@30Hz
Ethernet	2 x LAN :
	LAN1: Intel® I225V 2.5GbE controller
	LAN2: Intel® I225V 2.5GbE controller
Audio	1 x HD Audio : 1 x IAUDIO, support IEI AC-KIT-888S Audio Module (2 x 5 pin)
I/O Interface	2 x Internal RS-232/422/485 : 2x5 pin, P=2.00, RS-485 support AFC
	2 x External USB 3.2 Gen1x1 : 5Gb/s (Type-A)
	2 x Internal USB 2.0 : 2x4 pin, P=2.00
	DIO : 12-bit digital I/O (2x7 pin)
	1 x External USB 3.2 Gen2x1 : 10Gb/s (Type-C)
Expansion	1 x PCIe x16 :
	signal from CPU via golden finger
	(supports x16, or x8 + x8, or x4 + x4 + x8)

	1 x PCIe x4 : signal from PCH via golden finger (supports x4, or x1 + x1 + x1 + x1)
	2 x M.2(NGFF) : 1 x M.2 A key (2230) with PCIe Gen3 x2/USB 2.0 1 x M.2 M key (2280/2242) with PCIe Gen3 x4
Power	
Power Supply	5V/12V, ATX/AT power supply
	Support AT/ATX mode
	ErP/EuP Compliant
Environment	
Operating Temperature	0°C – 60°C
Storage Temperature	-30°C – 70°C
Humidity	5% ~ 95%, non-condensing
Certifications	
Safety & EMC	CE/FCC compliant

Ordering Information

HPCIE-Q470-R10	Half-size PICMG 1.3 CPU Card supports LGA1200 Intel® 10th Gen. Core™ i9/i7/i5/i3/Pentium®/Celeron® CPU with Q470E, DDR4 SO-DIMM, HDMI™, USB-C, Dual Intel® 2.5GbE, USB 3.2, SATA 6Gb/s, M.2, HD Audio, iAMT and RoHs
----------------	--

Packing List

1 x HPCIE-Q470 single board computer	2 x SATA cable
1 x I/O shielding	1 x QIG

Maximizes Design Flexibility

The HPCIE-Q470 is a half-size PICMG 1.3 SBC supporting 10th/11th generation Intel® Core™, Pentium® or Celeron® processor with Intel® Q470 chipset. Aimed at customers who are seeking compact system with high computing power and flexible expansion capabilities.

With versatile IEI passive backplanes and industrial chassis options, the compact configurable system offers increased computing efficiency, flexible I/O expandability especially with PCIe x16, PCIe x8 and legacy PCI signals through backplane allowing more industrial add-on cards to satisfy the requirements of performance-demanding applications in quality defect inspection, digital surveillance, transportation and automation applications.

Spec Overview

Performance | Component Side & Solder Side

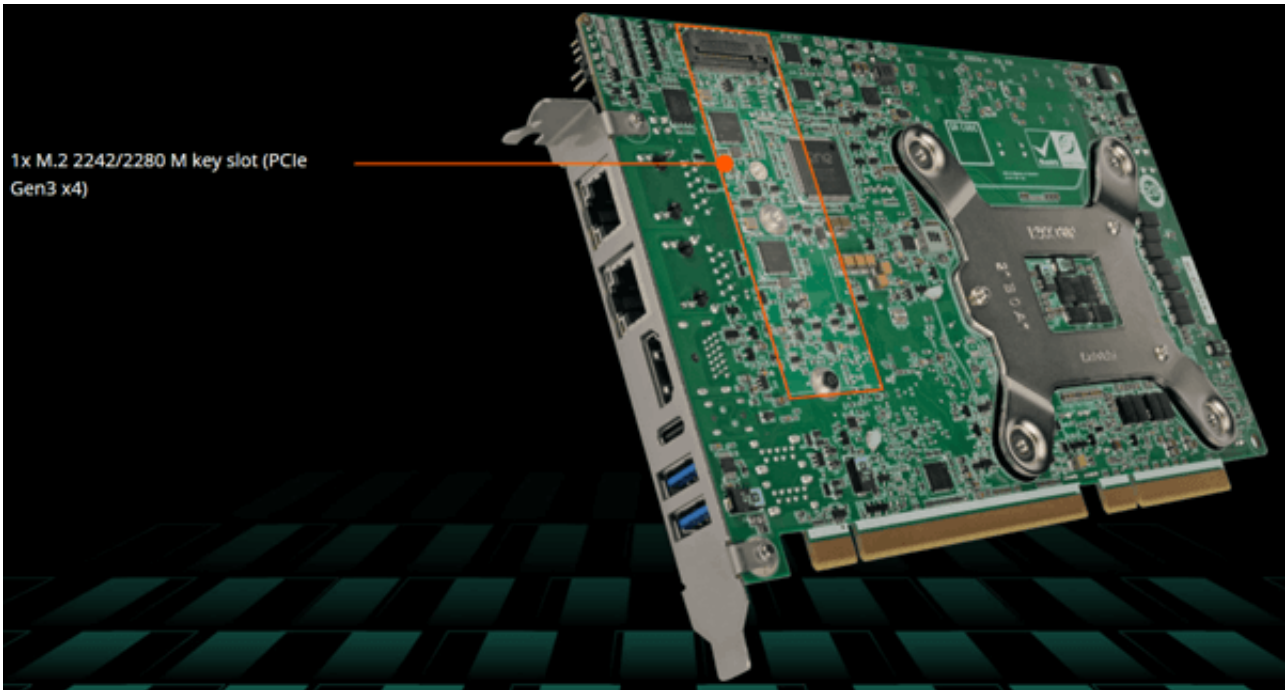
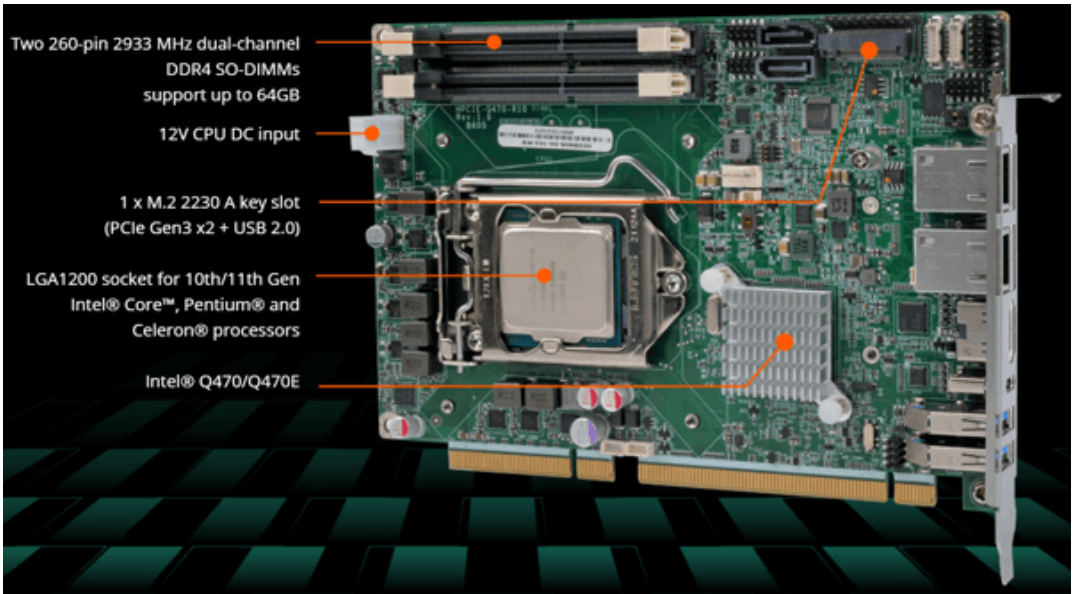

Connectivity

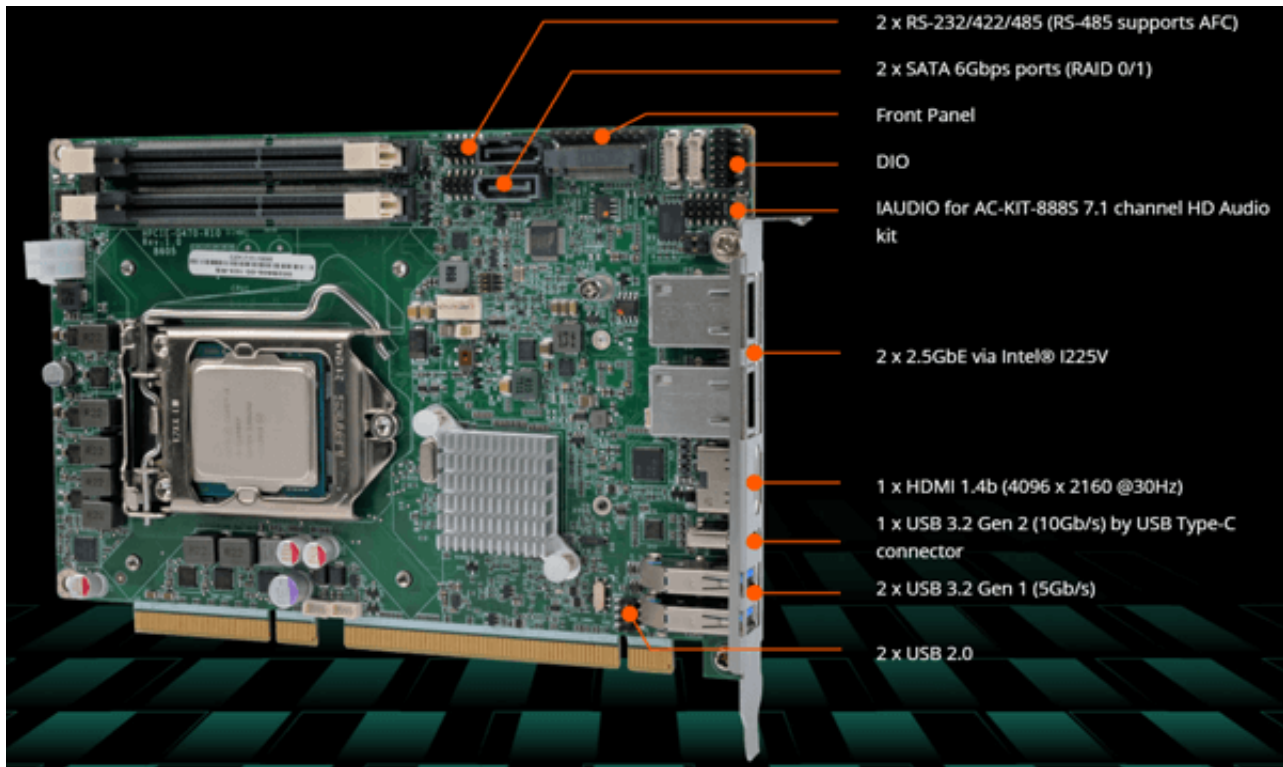

Cooling

CF-115XA	CF-1156C	CF-1156D	CF-115XE
1U chassis compatible, 73W	1U chassis compatible, 45W	1U chassis compatible, 65W	High performance, 95W

Half-size PICMG 1.3

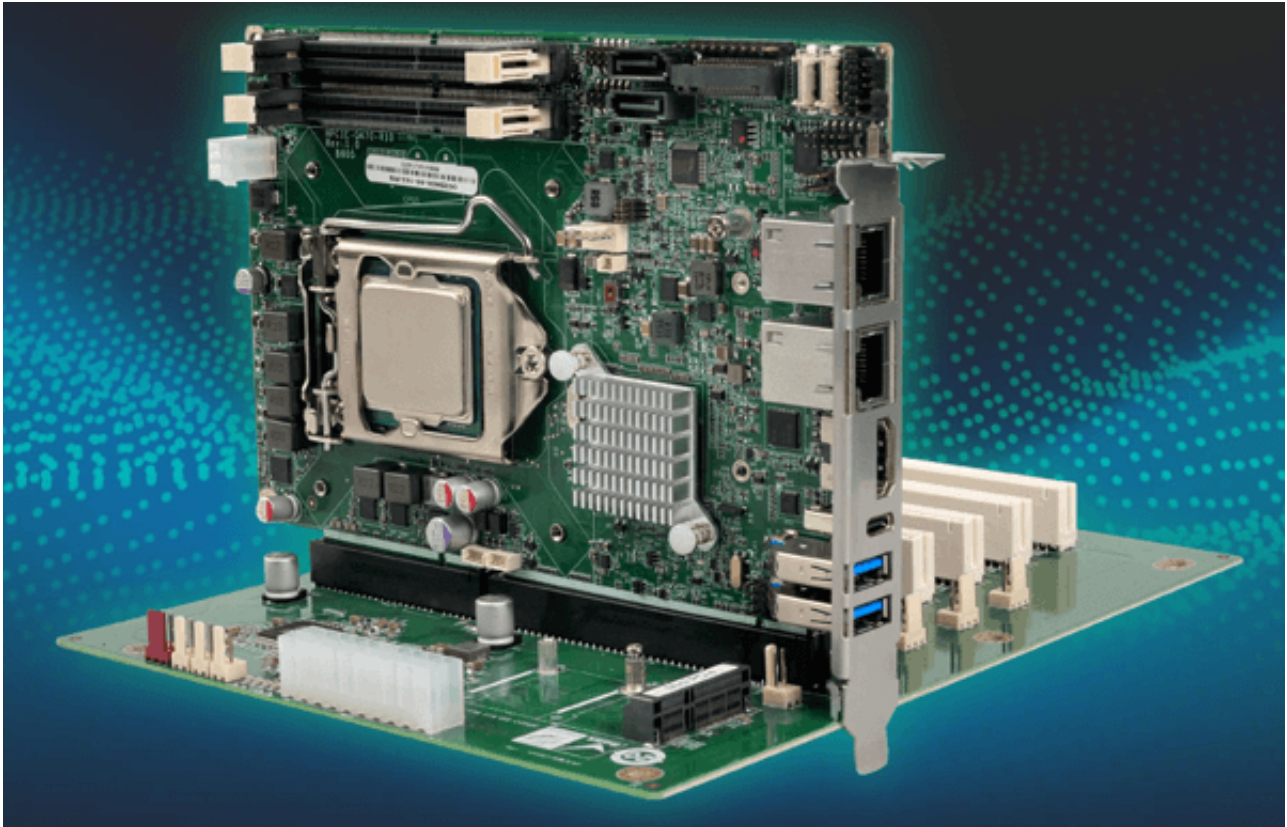

Standard PICMG 1.3 SBCs have several advantages over non-standard SBCs. Firstly, they are more maintainable than a motherboard system and have a much lower mean time to repair (MTTR). Secondly, it is easy to upgrade to a newer or faster processor if desired.

Features of PICMG 1.3:

*20 PCI Express: 20 PCI Express lanes are supported, including PCI Express x16, x8, x4 and x1 configurations

*ATX power signals are supported: Provides AUX voltages for standby power and sleep states (soft starts, wake on LAN), supports PSON#, PWRGD, PWRRBT# and ACPI states

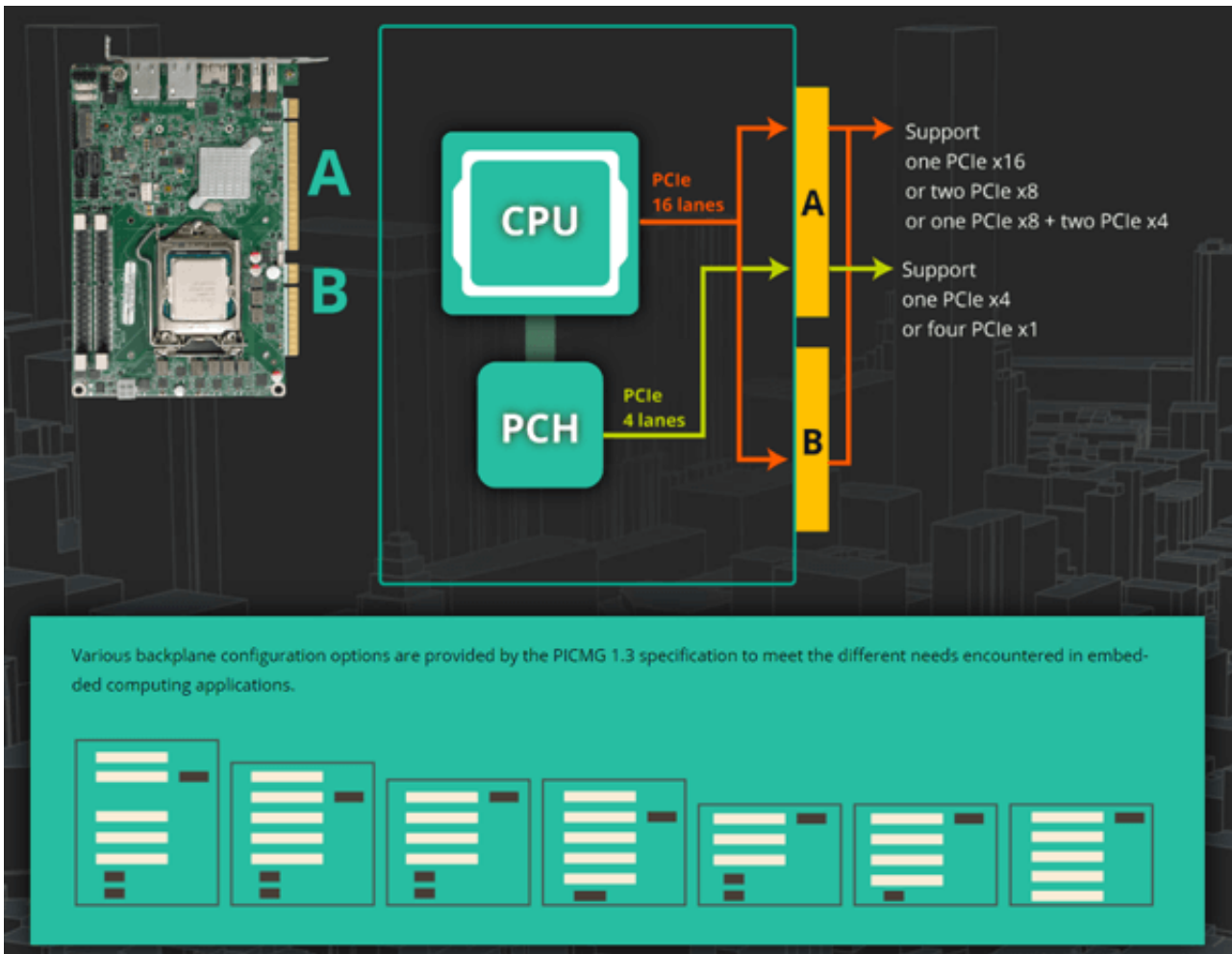

Enhanced CPU Performance

The performance boosts up to 80% better than previous generation on i5 processor. The 10th Gen Intel® Core platform supports up to 10 cores and improved performance over Coffee Lake-Refresh. With increased I/O capacity and the latest DDR4-2933 memory support, these processors deliver the performance required to consolidate industrial multiple workloads.

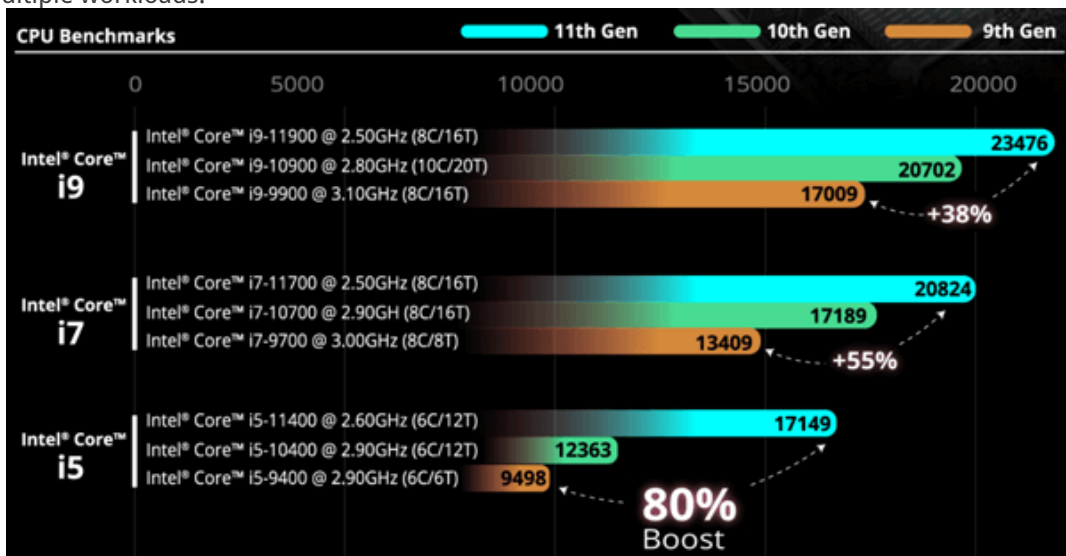

Embedded CPU Support List for 10th Gen Intel® Processors

Sockets	Brand	Process	Cores/Threads	CPU	Processor Base Frequency	Cache	TDP	Processor Graphics	Graphics Base Frequency	Memory Types	Chipset
FCPGA1200	Core™ i9	14nm Comet Lake-S	10/20	I9-10900E	2.8 GHz	20MB	65W	Intel® UHD Graphics 630	350 MHz	DDR4-2933	Q470/Q470E
			10/20	I9-10900TE	1.8 GHz	20MB	35W				
	Core™ i7		8/16	I7-10700E	2.9 GHz	16MB	65W				
			8/16	I7-10700TE	2.0 GHz	16MB	35W				
	Core™ i5		6/12	I5-10500E	3.1 GHz	8MB	65W				
			6/12	I5-10500TE	2.3 GHz	8MB	35W				
	Core™ i3		4/8	I3-10100E	3.2 GHz	9MB	65W				
			4/8	I3-10100TE	2.3 GHz	9MB	35W				
	Pentium®		2/4	G6400E	3.8 GHz	4MB	58W				
			2/4	G6400TE	3.2 GHz	4MB	35W				
	Celeron®		2/2	G5900E	3.2 GHz	2MB	58W				
			2/2	G5900TE	3.0 GHz	2MB	35W				

Delivering HDMI™ 4K Resolution for Real-time Monitoring



10 Gb/s USB 3.2 Gen 2 Type-C foolproof connector

USB Type-C connectors are widely adopted by many electronic devices, such as portable SSD hard drives, smart phones, USB cameras, etc. The HPCI-E-Q470 uses the reversible connector that should end the bane of users fiddling at the back of computers.

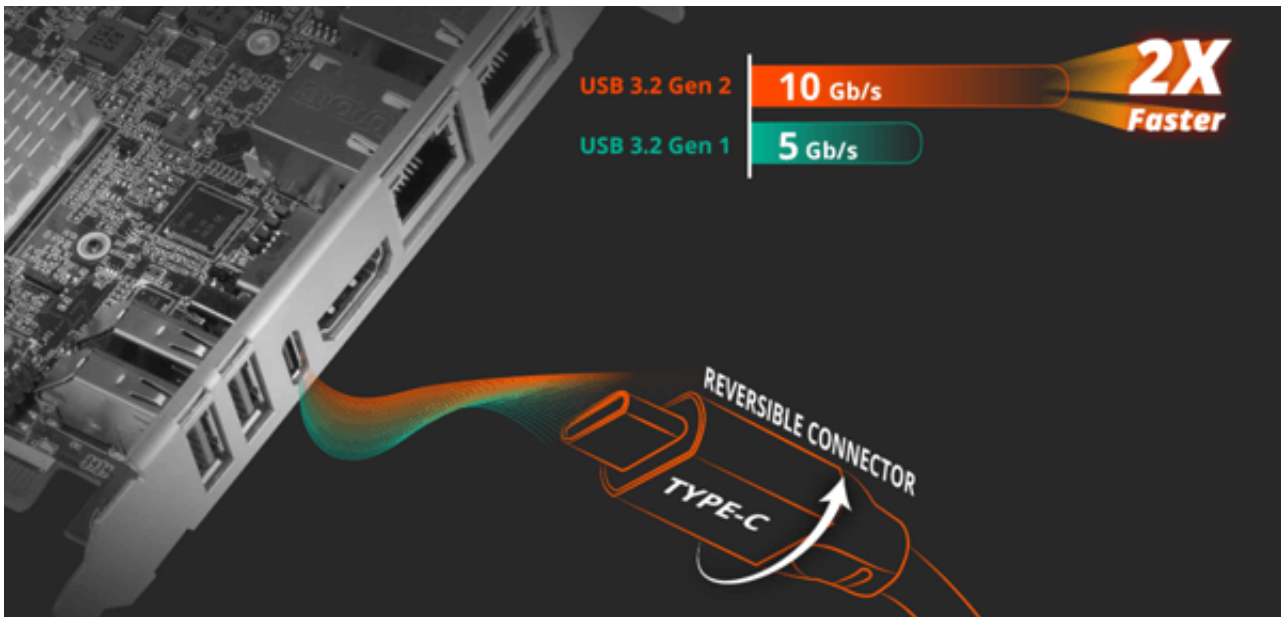

SATA 6 Gb/s Storage Performance with RAID 0/1 Protection

Protection:

- *Vibration free lockable SATA connectors and cables to protect the connection between HDD and SBC
- *RAID 1 with mirror function provides redundancy data protection

Performance:

- *RAID 0 enables faster storage performance with data striping to protect against data loss from a hard drive failure by mirroring all data across multiple devices.
- *SATA 6Gb/s is well suited for such as video editing because they require high performance to memory.

RAID 0 Speed Mode

RAID 0 mode (striping) provides higher data reading and writing performances by dividing a single file into two files and storing one on each drive.

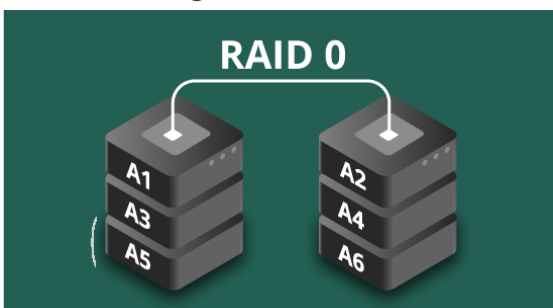

RAID 1 Safe Mode

RAID 1 mode (mirroring) backs up the identical data in both drives to prevent data loss from hard drive failure.

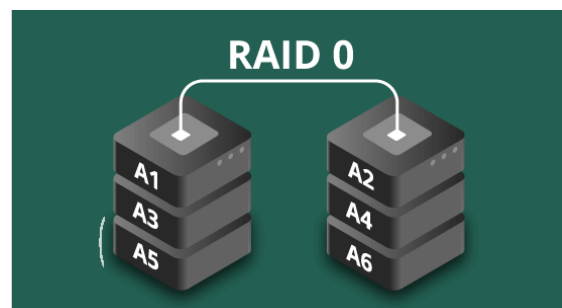

M.2 2230 A Key for Wi-Fi/Bluetooth

The M.2 2230 A key slot carrying with PCIe 3.0 x1 and USB 2.0 signals allows it to adopt the latest Wi-Fi 6E technology. Wi-Fi 6E enhances low latency and supports service levels that are equivalent to 5G networks.



Delivering Dual Low-Latency 2.5G LAN Powered by Intel

The two on-board Intel® I225V 2.5GbE controllers enable the HPCI-E-Q470 to meet the bandwidth-intensive requirements such as large file transfers and high-resolution video streaming.

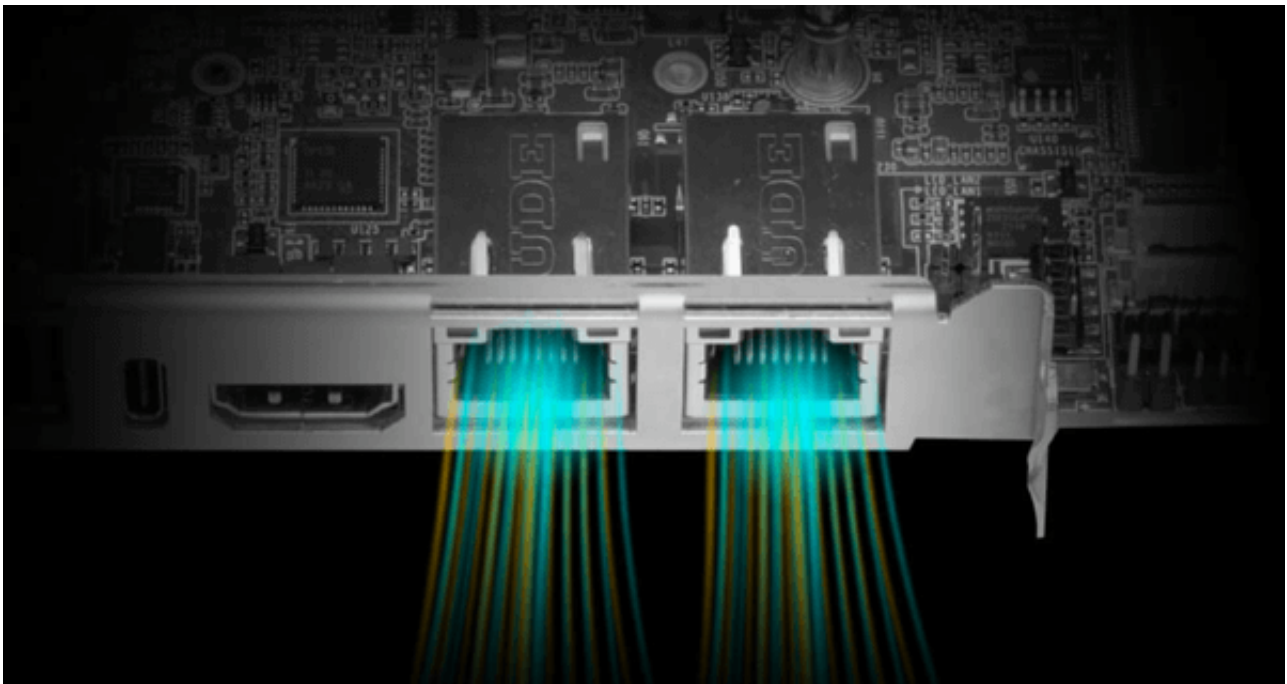

Instant System-level Solution

To suit different AIoT applications, IEI offers a comprehensive range of PICMG 1.3 passive backplanes and industrial chassis to give system designers expanded options for integrating multi-level processors within a variety of configurations.

Industrial Chassis				
	PR-1500G	PAC-125G	RACK-3000G	RACK-360G
	Wall-mount System	Wall-mount System	4U System	4U System
Dimensions (DxWxH) (mm)	254 x 286 x 132	254 x 286 x 132	254 x 286 x 132	254 x 286 x 132
PICMG 1.3 Half-size Backplane				
	HPXE2-5S1	HPXE2-8S1	HPXE2-8S1	HPXE2-8S1
PCI	2	2	4	4
PCIe Gen3 x16	1			
PCIe Gen3 x8		4	2	2